

## DC ISOLATING SWITCH



SISO-63

SISO-63S

- UV Resistant IP66 Enclosure
- Extremely Short Power Shut Off Time Of Approx.2ms
- Lid Only Removable In "off" Position
- Earth Terminal
- IEC60947-3,AS/NZS 3947.3: 2001
- DC21B 10A To 63A UP To DC1500v
- Easy To Install





### Specifications

Rated Voltage	600VDC TO 1500VDC
IP Rating	IP66
Connection Type	M20 M25 MC4
Rated Current	10A,16A,20A,25A, 32A,40A,50A,63A
Working Temperature	-5°C~+60°C
Standard	IEC 60947-3, AS/NZS 3947.3:2001

This product passed IEC authorized Lab IP66 waterproof testing. Also our company will take simulation tests irregularly, similar to customer's using environment, to make sure this product completely conforms to IP66 protection grade

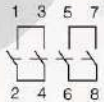
## Specifications

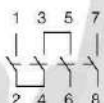
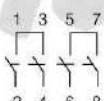
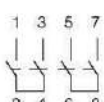
Contact configuration	600V	800V	1000V	1200V	Poles in series	Number of strings	Type Number
	16A	16A	9A	9A	2	1	SISO-16P2
	25A	20A	11A	11A	2	1	SISO-25P2
	32A	23A	13A	13A	2	1	SISO-32P2
	29A	16A	9A	9A	2	1	SISO-16P2H
	45A	20A	11A	11A	2	1	SISO-25P2H
	50A	23A	13A	13A	2	1	SISO-132P2H
	16A	16A	9A	9A	2	2	SISO-16P4
	25A	20A	11A	11A	2	2	SISO-125P4
	32A	23A	13A	13A	2	2	SISO-32P4
	16A	16A	16A	16A	4	1	SISO-16P4S
	25A	25A	25A	25A	4	1	SISO-25P4S
	32A	32A	32A	32A	4	1	SISO-32P4S
	16A	16A	16A	16A	4	1	SISO-16P4B
	25A	25A	25A	25A	4	1	SISO-25P4B
	32A	32A	32A	32A	4	1	SISO-32P4B
	16A	16A	16A	16A	4	1	SISO-16P4T
	25A	25A	25A	25A	4	1	SISO-25P4T
	32A	32A	32A	32A	4	1	SISO-32P4T

1500V DC voltage require customized

### Contact Configuration

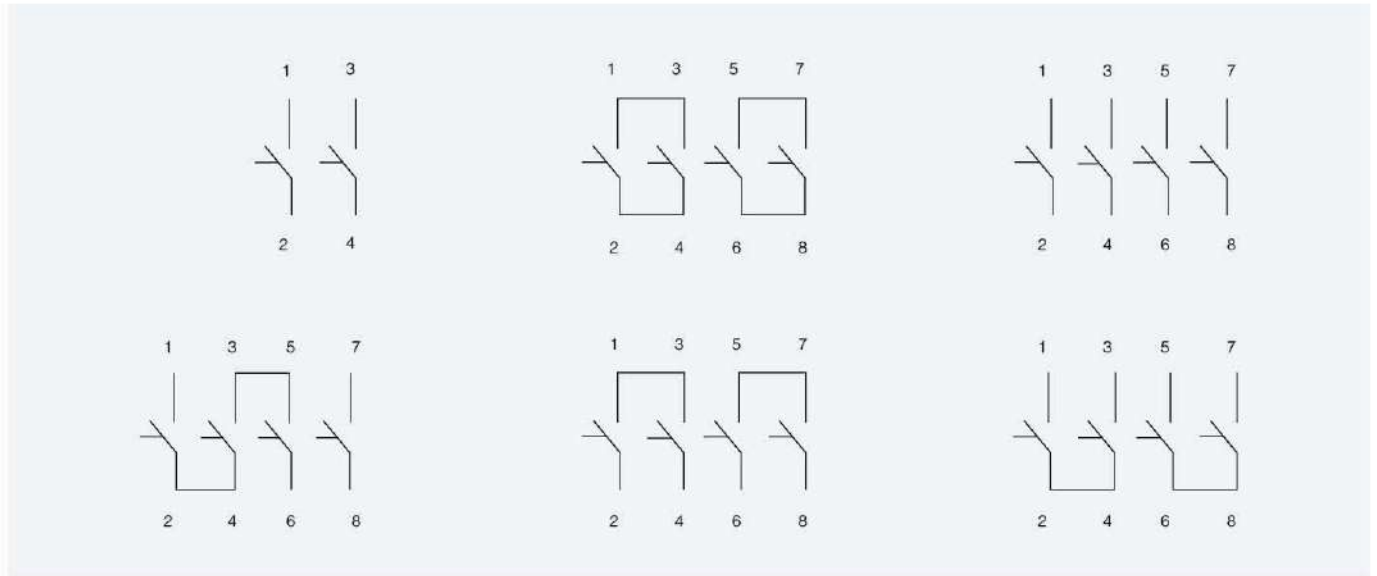

### Dimensions(mm)

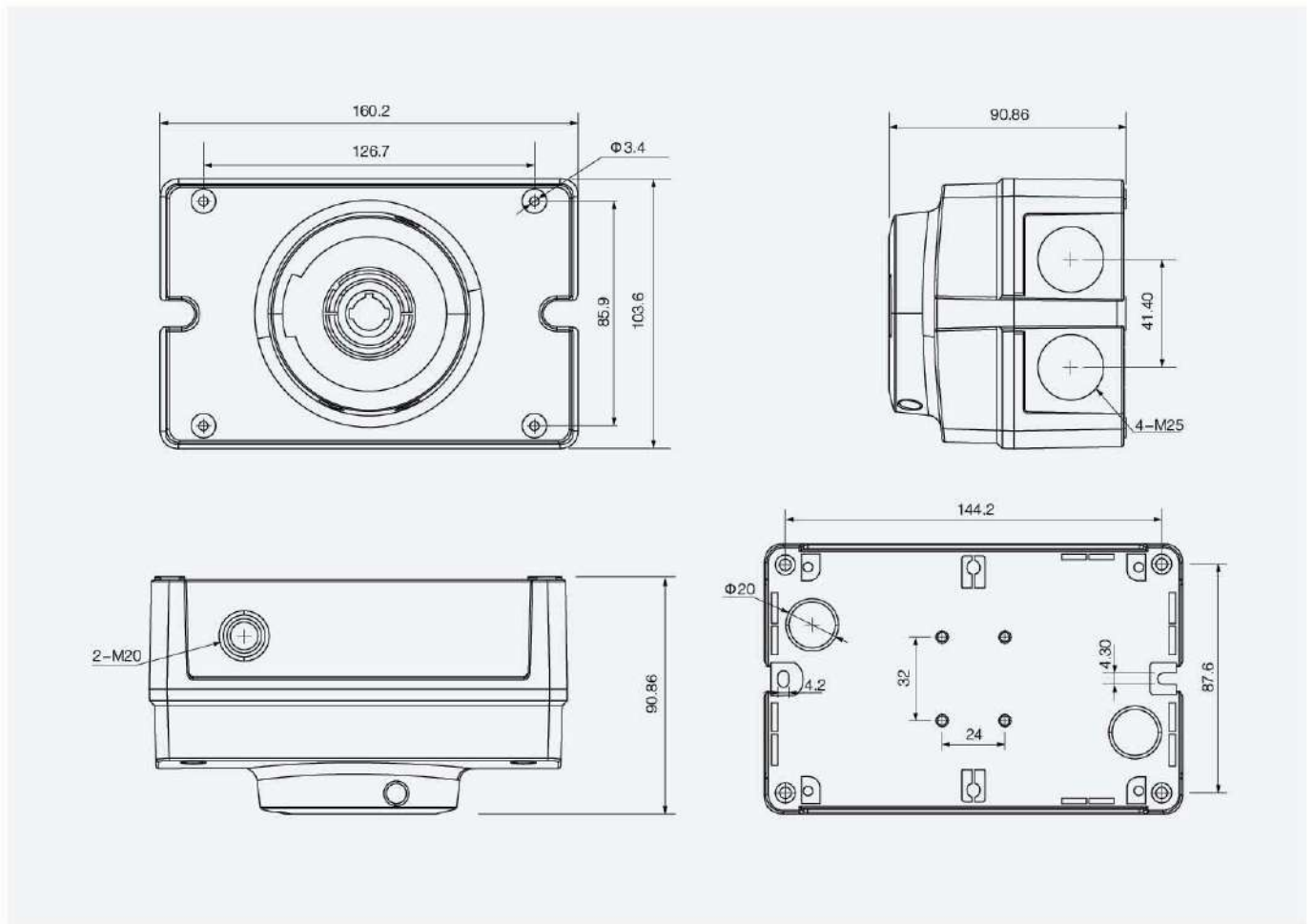



## Main Switch for DIN Rail Mounting

- DIN rail mounting
- Extremely short power shut off time of approx. 3ms
- 2 poles and 4 poles available
- IEC60947-3 standard
- DC21B: 16A, 25A and 32A up to 1500V DC

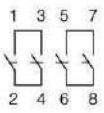
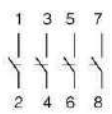
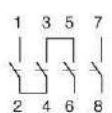
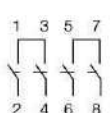
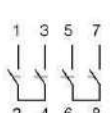

### Specifications

Contact configuration	600V	800V	1000V	1200V	Poles In series	Number of strings	Type Number
	16A	16A	16A	9A	2	1	SISO.2-16 D2
	25A	25A	20A	11A	2	1	SISO.2-25 D2
	32A	32A	23A	13A	2	1	SISO.2-32 D2
	29A	29A	16A	9A	2	1	SISO.2-16 D2H
	45A	45A	20A	11A	2	1	SISO.2-25 D2H
	58A	58A	23A	13A	2	1	SISO.2-32 D2H
	16A	16A	16A	9A	2	2	SISO.2-16 D4
	25A	25A	20A	11A	2	2	SISO.2-25 D4
	32A	32A	23A	13A	2	2	SISO.2-32 D4
	16A	16A	16A	16A	4	1	SISO.2-16 D4S
	25A	25A	25A	25A	4	1	SISO.2-25 D4S
	32A	32A	32A	32A	4	1	SISO.2-32 D4S
	16A	16A	16A	16A	4	1	SISO.2-16 D4B
	25A	25A	25A	25A	4	1	SISO.2-25 D4B
	32A	32A	32A	32A	4	1	SISO.2-32 D4B
	16A	16A	16A	16A	4	1	SISO.2-16 D4T
	25A	25A	25A	25A	4	1	SISO.2-25 D4T
	32A	32A	32A	32A	4	1	SISO.2-32 D4T

1500V DC voltage require customized

## Switching Configurations

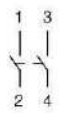
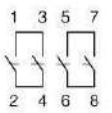
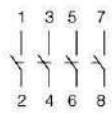
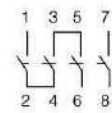
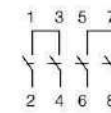
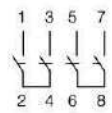
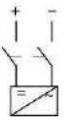
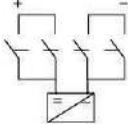
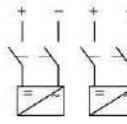
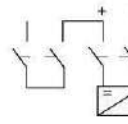
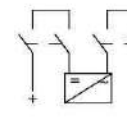
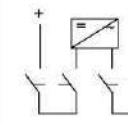
Type	2-pole	2-pole 4 paralleled poles	4-pole	4-pole with Input on top output bottom	4-pole with Input and output bottom	4-pole with Input and output on top
SISO.2-16	2	2H	4	4S	4B	4T
SISO.2-25	2	2H	4	4S	4B	4T
SISO.2-32	2	2H	4	4S	4B	4T
Contacts Wiring graph						
Switching example						

## Dimensions(mm)

